

Network Planning Policies for Joint Switching in Spectrally-Spatially Flexible Optical Networks

Mohsen Yaghubi-Namaad
Faculty of Electrical Engineering
Sahand University of Technology
Tabriz, Iran
m_yaghubi@sut.ac.ir,

Akbar Ghaffarpour Rahbar*
Faculty of Electrical Engineering
Sahand University of Technology
Tabriz, Iran
ghaffarpour@sut.ac.ir

Behrooz Alizadeh
Faculty of Applied Mathematics
Sahand University of Technology
Tabriz, Iran
alizadeh@sut.ac.ir

Received: 22 April 2018 - Accepted: 13 July 2018

Abstract—The spectrally and spatially flexible optical networks (SS-FON) are the promising solution for future optical transport networks. The joint switching (J-Sw) paradigm is one of the possible switching schemes for SS-FON that brings optical component integration alongside with acceptable networking performance. The network planning of J-Sw is investigated in this paper. The formulation of resource allocation for J-Sw is introduced as in integer linear programming to find the optimal solution. To find the near-optimal solution, the heuristic algorithms are initiated with sorted connection demands. The way connection demands are sorted to initiate the heuristic algorithms affects the accuracy of algorithms. Therefore, six different sorting policies are introduced for J-Sw. Moreover, the heuristic algorithm called joint switching resource allocation (JSRA) algorithm is introduced, especially for J-Sw. The heuristic algorithm performance initiated with different sorting policies is investigated through simulation for a small-size network. The optimality gap is the most important indicator that shows the effect of each sorting policy on the near-optimal solution. The new sorting policy of connection demands called descending frequency width (DFW) policy achieved the least optimality gap. Also, the JSRA performance initiated with these sorting policies is investigated for a real network topology. The obtained results indicate that DFW shows better performance than other sorting policies in realistic networks, too.

Keywords- Optical transport networks; SS-FON; Space division multiplexing; Joint switching; Network planning; Static traffic; Resource allocation; RMLSSA; Sorting policies.

I. INTRODUCTION

The exponentially increase of backbone traffic and variety of connection's bandwidth necessitated reconsideration of optical transport networks implemented by rigid fixed wavelength division multiplexing networks [1]. Currently, bandwidth variable transponders (BVT) and spectrum selective switches (SSS) have made the so-called elastic optical networks (EON) practical [2-4]. EONs are capable of

constructing and switching the connection's lightpath including contiguous frequency slots (FS) as an entity called spectral superchannel [5] with different bandwidths and data rates (e.g., by changing the number of FSs or used modulation). Even though, EON provides efficient use of spectrum, but the available spectrum of single mode fiber (SMF) is limited [6]. Thus, the spectrally-spatially flexible optical networks (SS-FON) using space division multiplexing (SDM) is the proposed solution to extend the capacity of future

*Corresponding Author

optical transport networks [7-9]. SS-FON provides space diversity using different spatial paths to transmit optical signals by extending the lightpath as a spatial-spectral superchannel [8, 10-12]. The transmission media of SS-FON could be SMF bundles, multicore fibers (MCF), multimode fibers (MMF), or multicore-multimode fibers (MC-MMF). Each fiber type suffers from different physical layer impairments and imposes different constraints to the resource allocation problem. Accordingly, different switching paradigms are introduced to implement SS-FONs in [13], and their required optical components and implementation technologies are discussed in [14].

In SS-FON, three switching paradigms are [8, 15]: (a) independent switching (Ind-Sw) that makes it possible to direct any spatial path independently to any output port; (b) joint switching (J-Sw) that switches all the spatial paths altogether, and (c) fractional joint switching (FrJ-Sw) that switches subgroups of spatial paths as an entity. The performance of different switching paradigms are investigated in regard to the number of needed transponders [15], required number of SSS [10], and traffic profile effect [16, 17]. Also, the fragmentation problem has been addressed in [18-20]. Ind-Sw brings out higher network performance for dynamic traffic, but it requires more complex switches. In addition, the used transmission media should have no crosstalk or energy coupling between spatial paths, e.g., use of SMF bundles or weak coupled MCFs. FrJ-Sw performance is between Ind-Sw and J-Sw. On the other hand, the reduction of cost per bit and transceivers number are the important outcomes of J-Sw. Also, it is possible to use all the SDM fibers in J-Sw. Therefore, J-Sw is an interesting solution for migration of an optical transport network to a full flexible one. Thus, the network planning of SS-FONs with J-Sw paradigm is investigated in this paper.

TABLE I. LIST OF ACRONYMS

AFN	Ascending frequency width
ASN	Ascending SAL number
BVT	Bandwidth variable transponder
DFN	Descending FS number
DFW	Descending frequency width
EON	Elastic optical network
FrJ-Sw	Fractional joint switching
FS	Frequency slot
ILP	Integer linear programming
Ind-Sw	Independent switching
JSRA	Joint switching resource allocation
J-Sw	Joint switching
MCF	Multicore fiber
MC-MMF	Multicore-multimode fiber
MMF	Multimode fiber
MUFSI	Maximum utilized frequency slot index
OSU	Overall spectrum utilization
RMLSSA	Routing, modulation level, space, and spectrum assignment
SAL	Space and spectrum assignment layouts
SARA	Switching adaptable resource allocation
SDM	Space division multiplexing
SMF	Single mode fiber
SS-FON	Spectrally-spatially flexible optical networks
SSS	Spectrum selective switch

TABLE II. LIST OF NOMENCLATURES

D	Set of connection demands
E	Set of links
f_i	The i^{th} frequency slot
F	Ordered set of FSs
g_w	Spectral guardband
G	Connected graph represents the network topology
h_q	Number of spatial paths in SAL q
k	Number of pre-determined routes for each connection demand
M_{\max}^{π}	The highest attainable modulation level
n_{d,π_d}	Connection demand required FS
N^d	Summation of n_{d,π_d} of every candidate route of the connection demand
Q_{d,π_d}	Set of possible SALs for required number of FSs
\tilde{Q}_{d,π_d}	Set of possible SALs for required number of FSs with guardbands
R_d	Data rate of the connection demand
R_{fs}	FS base capacity
s_d	The source node
S^d	summation of all the possible SALs over the candidate routes of the connection demand
t_d	Destination node
u	Objective function of ILP formulation
V	Set of nodes
w_q	Frequency width in SAL q
w_{qg}	Frequency width in SAL q with guardbands
$w_{q,\pi}$	Smallest width of possible SALs over route π
W^d	Summation of frequency widths over the candidate routes of the connection demand
α^x	Decision variable for route selection
β_q^{π}	Decision variable for SAL selection
$\chi_{\delta,f}^{\pi,q}$	Decision variable for corner FS selection
δ_i	The i^{th} Spatial path
Λ	Ordered set of spatial paths on each link
$\gamma_{\delta,f}^{\pi,q}$	Decision variable of used resources over the route
O_f	Decision variable of used FSs in the network
Π	Set of all routes for every connection demand
Π_d	Set of pre-determined candidate routes for connection demand d
θ	Number of spatial paths
Ω_e	All the routes that go through link e
$\zeta_{\delta,f}^e$	Decision variable of used resources over the links
ψ	Maximum number of FSs

The network planning objective is to find the minimum required spectral resources to allocate all the pre-known connection demands as static traffic of network. Meanwhile, the resource allocation of SS-FON includes route, modulation level, space, and spectrum assignment (RMLSSA) which is NP-hard. We have investigated the resource allocation problem of SS-FONs implemented by SMF bundles and MCFs as an integer linear programming (ILP) formulation in [21]. Later, we extended that work to consider the switching paradigms and networking approaches in [22]. Heuristic algorithms have been proposed to achieve near-optimal solutions, e.g., switching

adaptable resource allocation (SARA) algorithm in [22]. However, optimal and near-optimal solutions depend on many parameters such as network topology, connectivity degrees of nodes, number of spatial paths, traffic load, and used modulation adaptivity and so on. On the other hand, heuristic algorithms try to solve the network planning problem by serving the connection demands one by one. Accordingly, the sorting policy of connection demands is the important parameter that affects the optimality of heuristic algorithms, when other operational parameters are fixed. For J-Sw, the SARA's ability was comparable and weaker from other SDM networking approaches with the same proposed sorting policies [22]. This motivated us to investigate the effect of sorting policies on the network planning of J-Sw. Therefore, our objective is to increase the accuracy of the obtained near-optimal solution. Moreover, we introduce a new heuristic algorithm called joint switching resource allocation (JSRA) with lower computational complexity compared to the SARA. Then, we evaluate JSRA's performance with different sorting policies through simulation and compare the results with optimal solution that is obtained from ILP [22] for a small topology network. Then, we evaluate JSRA's performance for real network experiment. Note that this work is an extension of our previous work presented in [20]. This extension is carried out by formulating resource allocation, introducing more sorting policies, providing more simulations with accurate results, and investigating the effect of the sorting policies on the heuristic algorithm performance.

Accordingly, this paper contributions are (1) investigating the performance of heuristic algorithm initiated with different sorting policies of connection demands, (2) introducing a new metric to sort connection demands which leads to more accurate solution, and (3) introducing JSRA algorithm designed especially for J-Sw with less computational complexity. The objective of this work is to find the better near-optimal solution than previous works.

Table I and Table II summarize the list of acronyms and nomenclatures, respectively. The rest of this paper is organized as follows. In Section II, we discuss the resource allocation formulation of J-Sw. In Section III the sorting policies and heuristic algorithm are introduced. In Section IV, the simulation results are demonstrated. Finally, Section V concludes the paper.

II. RESOURCE ALLOCATION FORMULATION FOR JOINT SWITCHING

The resource allocation problem of joint switching is formulated in this section. The resource allocation includes route, modulation level, space, and spectrum assignment for connection demands. The objective of network planning is to find the minimum number of utilized FSs to establish all the connections in pre-determined candidate routes without blocking for a given traffic matrix. Traffic matrix specifies the requested transmission data rates of all connections. The establishment of connections must satisfy spectrum contiguity (i.e., allocating adjacent FS) and spectrum continuity (i.e., using the same spectrum over the links) constraints.

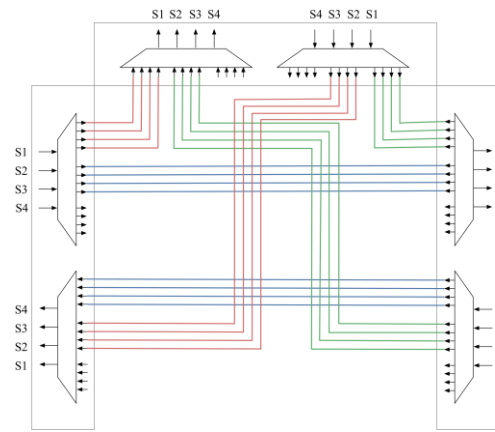

Fig.1. Switching node for J-Sw adopted from [13].

On the other hand, in J-Sw, all the spatial paths are allocated to one connection and switching is performed for spectral slices of all spatial paths. The suggested switching node implementation is shown in Fig. 1 [13] with node degree of 3 and four spatial paths. Note that different colours specify different slices of available spectrum, but from all the spatial paths. Accordingly, the spatial contiguity is not required because all the spatial paths are allocated to one connection demand. However, we will consider the spatial continuity to eliminate any lane change in J-Sw paradigms that could be implemented by MCFs or SMF bundles.

A. Notations

Consider a connected graph $G=(V,E)$ as a representation of the network topology. The set of nodes is V and the set of links is E . Thus, number of nodes and links are specified by $|V|$ and $|E|$, respectively. Let denote θ as the number of spatial paths and specify each spatial path by δ_i . Accordingly, there is an ordered set of spatial paths on each link denoted by $\Delta=\{\delta_0,\delta_1,\dots,\delta_{\theta-1}\}$. Moreover, frequency slots of each spatial path is denoted by $F=\{f_1, f_2, \dots, f_\psi\}$. Note that maximum number of FSs ψ must be set in a way to guarantee all the connection demands to be assigned in network planning, but the maximum number of spatial paths is intrinsic property of network. It is noteworthy to mention that spatial paths set Δ differs based on the type of fiber in use. For example, Δ includes cores for MCF, but Δ includes modes for MMF.

The set of connection demands is denoted by D as in (1). Each triple (s_d, t_d, R_d) determines connection demand d between a source node $s_d \in V$ and destination node $t_d \in V$. Moreover, the required data rate of connection demand is denoted by $R_d \in \mathbf{Z}^+$.

$$D = \bigcup_{\substack{s_d, t_d \in V \\ R_d \in \mathbf{Z}^+}} d(s_d, t_d, R_d). \quad (1)$$

It is assumed that k pre-determined routes are used for each connection demand. Let Π_d be the non-empty set of pre-determined candidate routes between s_d and t_d for connection demand $d \in D$ as in (2). Let Π denote the set of all routes for every connection demand as defined in (3). The subset $E_\pi \subseteq E$ specifies the route

$\pi \in \Pi$. Therefore, Equation (4) determines all the routes that go through link e as Ω_e .

$$\Pi_d = \bigcup_{(s_d, t_d) \in V^2} \pi_{s_d t_d}, d(s_d, t_d, R_d) \in D. \quad (2)$$

$$\Pi = \bigcup_{d \in D} \Pi_d. \quad (3)$$

$$\Omega_e = \{ \pi | \pi \in \Pi, e \in E_\pi \}. \quad (4)$$

For each connection demand d and candidate route $\pi_d \in \Pi_d$, the required number of FSs n_{d, π_d} is determined by (5), where R_d is the required data rate and R_{fs} is the FS base capacity. The R_{fs} is specified regarded to the FS bandwidth when single polarized-BPSK modulation is used for each subcarrier [18]. Using higher level modulation (i.e., increasing the bit per symbol rate) results in increasing FS capacity. On the other hand, using polarization division multiplexing doubles the FS capacity. For example, using dual polarized-QPSK increases the FS capacity by four folds. Therefore, parameter M_{\max}^π specifies the highest attainable modulation level of candidate route π_d [19]. Note that quality of transmission considerations determines this highest possible modulation level. Here, it is assumed that the routing length determines the highest possible modulation level as in [19].

$$n_{d, \pi_d} = \left\lceil \frac{R_d}{M_{\max}^\pi \times R_{fs}} \right\rceil. \quad (5)$$

Note that Equation (6) calculates the upper bound of ψ to serve all connection demands without blocking, where the BPSK modulation is considered for all the routes.

$$\psi = \sum_{d \in D} \left\lceil \frac{R_d}{R_{fs}} \right\rceil. \quad (6)$$

The space and spectrum assignment layout (SAL) is introduced as how n_{d, π_d} FSs can be assigned through h_q spatial paths with w_q frequency slots width [18]. Now, the possible SALs for n_{d, π_d} is determined as \mathcal{Q}_{d, π_d} by (7). Note that the maximum number of FSs ψ in each spatial path bounds w_q and maximum number of spatial paths θ bounds h_q .

$$\mathcal{Q}_{d, \pi_d} = \{ (h_q, w_q) | n_{d, \pi_d} = h_q \times w_q, \quad (7)$$

$$h_q, w_q, n_{d, \pi_d} \in \mathbf{Z},$$

$$1 \leq h_q \leq \theta,$$

$$1 \leq w_q \leq \psi \}$$

J-Sw requires that all of the spatial paths are allocated to the same connection demand. Therefore, when there is unused spatial paths ($h_q < \theta$), it is not allowed to use these unused resources to other

connection demands. Accordingly, $h_{qg} = \theta$ is introduced to update the value of h_q and prevent allocating of the same spectrum of spatial paths to different connection demands. Moreover, enabling spectral guardband can be performed by adding the required spectral guardband g_w to w_q as (8). Finally, set $\tilde{\mathcal{Q}}_{d, \pi_d}$ is created with new values h_{qg} and w_{qg} as in (9).

$$w_{qg} = w_q + g_w. \quad (8)$$

$$\tilde{\mathcal{Q}}_{d, \pi_d} = \{ (h_{qg}, w_{qg}) | (h_q, w_q) \in \mathcal{Q}_{d, \pi_d} \}. \quad (9)$$

B. Decision Variables

The required decision variables for ILP formulation are listed in the following.

- $\alpha^\pi \in \{0,1\}$ is a Boolean variable that indicates whether route π is the chosen route of connection demand d . If route π is selected from the candidate routes Π_d , this decision variable will be 1, but α^π will be 0, otherwise.
- $\beta_q^\pi \in \{0,1\}$ is a Boolean variable that indicates whether SAL q is chosen from set $\tilde{\mathcal{Q}}_{d, \pi_d}$ of route π to allocate connection demand d . If q is selected from different SALs, this decision variable will be 1, but β_q^π will be 0, otherwise. Specified SAL determines the required number of spatial paths (h_{qg}) and frequency width (w_{qg}).
- $\chi_{\delta, f}^{\pi, q} \in \{0,1\}$ is a Boolean variable. If frequency slot f is selected from spatial path δ as the corner FS of the allocated spectrum for connection demand d along route π by SAL q , this equals to 1; otherwise, equals to 0. The corner FS is defined as the starting point of performing resource allocation.
- $\gamma_{\delta, f}^{\pi, q} \in \{0,1\}$ is a Boolean variable. FS f is selected from spatial path δ to allocate the spectrums of connection demand d along route π by SAL q , this equals to 1; otherwise, it equals to 0.
- $\zeta_{\delta, f}^e \in \{0,1\}$ is a Boolean variable that indicates whether FS f from spatial path δ is occupied on link $e \in E$.
- $o_f \in \{0,1\}$ is a Boolean variable that indicates whether FS f is occupied on at least one spatial path over the network.

To illustrate SALs, consider a network with 5 spatial paths in each link and connection demand with $n_{d, \pi_d} = 3$ required FSs. This connection demand has two possible SALs. Accordingly, set $\mathcal{Q}_{d, \pi_d} = \{(1,3), (3,1)\}$ will be created according to (7). The first SAL specifies the resource allocation scheme with $h_q=1$ spatial path which includes $w_q=3$ FSs. Similarly, spectrum assignment can be performed by selecting $h_q=3$ spatial paths which includes $w_q=1$ FS. Now, considering $g_w=1$ spectral guardband and allocating all the spatial paths to one connection demand, set $\tilde{\mathcal{Q}}_{d, \pi_d} = \{(5,4), (5,2)\}$ will be updated accordingly.

		Corner FS									
		f_1	f_2	f_3	f_4	f_5	f_6	f_7	f_8	f_9	f_{10}
a)	δ_0	$\zeta_{\delta,f}^e$	$\zeta_{\delta,f}^e$		$\zeta_{\delta,f}^e$	$\zeta_{\delta,f}^e$	$\chi_{\delta,f}^{\pi,q}$	$\gamma_{\delta,f}^{\pi,q}$			
	δ_1	$\zeta_{\delta,f}^e$	$\zeta_{\delta,f}^e$		$\zeta_{\delta,f}^e$	$\zeta_{\delta,f}^e$	$\gamma_{\delta,f}^{\pi,q}$	$\gamma_{\delta,f}^{\pi,q}$			
	δ_2	$\zeta_{\delta,f}^e$	$\zeta_{\delta,f}^e$		$\zeta_{\delta,f}^e$	$\zeta_{\delta,f}^e$	$\gamma_{\delta,f}^{\pi,q}$	$\gamma_{\delta,f}^{\pi,q}$			
	δ_3	$\zeta_{\delta,f}^e$	$\zeta_{\delta,f}^e$		$\zeta_{\delta,f}^e$	$\zeta_{\delta,f}^e$	$\gamma_{\delta,f}^{\pi,q}$	$\gamma_{\delta,f}^{\pi,q}$			
	δ_4	$\zeta_{\delta,f}^e$	$\zeta_{\delta,f}^e$		$\zeta_{\delta,f}^e$	$\zeta_{\delta,f}^e$	$\gamma_{\delta,f}^{\pi,q}$	$\gamma_{\delta,f}^{\pi,q}$			
b)		o_f	o_f	o_f	o_f	o_f	o_f				

Fig. 2. (a) Route dependent decision variables $\chi_{\delta,f}^{\pi,q}$, $\gamma_{\delta,f}^{\pi,q}$ and $\zeta_{\delta,f}^e$, (b) the network dependent decision variable o_f for ILP formulation.

Fig. 2 shows the corner FS and the used decision variables to allocate this connection demand in J-Sw. Fig. 2.a shows the occupation status for candidate route π . The route occupation status of a given route is obtained regarded to the resource occupancy of route links.

Assume that the candidate route includes three links and the shaded squares $\zeta_{\delta,f}^e$ demonstrates that this shaded FS is occupied for another connection demand in one of links. One possible corner FS for SALs with $h_{qg}=5$ spatial paths and $w_{qg}=2$ FSs is marked by filled square $\chi_{\delta,f}^{\pi,q}$. Based on this SAL, the occupied $\gamma_{\delta,f}^{\pi,q}$ are shaded. Note that the other SAL with $h_{qg}=5$ and $w_{qg}=4$ could be allocated with this corner FS too. But, the objective of resource allocation should choose the SAL with smaller frequency width that occupies lower resources. Thus, decision variable o_f will be updated as shown in Fig. 2.b, which shows the used FS indexes over the network.

C. The ILP Formulation

Here, the RMLSSA formulation is presented for J-Sw as an integer linear programming problem. The resource allocation is formulated with objective function u as (10) subject to constraints (11)-(19). The objective is to minimize the utilized FSs (i.e., assigned to at least one connection demand) over the network. Accordingly, the objective function counts the number of used FS indexes from set F . For each connection demand $d \in D$, the route selection constraint is ensured by (11) in which one and only one route is selected from the candidate routes of set Π_d . The length of the chosen route specifies modulation level in regard to the required quality of transmission. After that, the SAL selection constraint is ensured by (12) in which one and only one SAL is chosen between the possible SALs in set \tilde{Q}_{d,π_d} of the chosen route. Moreover, (12) ensures no SAL selection for other candidate routes. For each connection demand d , the location of a corner FS of chosen SAL is ensured by (13) in the selected route as the corner FS selection constraint.

When there is not enough FS width, (14) forces $\chi_{\delta,f}^{\pi,q}$ to be zero and excludes such corner FS selections. According to the value of w_{qg} , set $F_{ex} = \{f_k \in F \mid \psi - w_{qg} + 2 \leq k \leq \psi\}$ determines the set of frequency slots that could not be chosen as corner FS. On the other hand, considering that all the spatial paths must be allocated to one connection demand and

accordingly, h_{qg} equals θ . Therefore, the corner FS selection of J-Sw must be performed in the first spatial path. Thus, set $\Delta_{ex} = \{\delta_k \in \Delta \mid k \neq 0\}$ determines the other corner FS selections which have not enough spatial paths, and exclusion of them is carried out by (15) similarly.

The spectrum contiguity constraint forces that if FS n is selected as the corner FS for connection demand d , then w_{qg} consecutive FSs should be assigned to this connection demand too. This spectrum contiguity is ensured by (16) with contiguity sets $N_{con} = \{f_k \in F \mid 1 \leq k \leq \psi - w_{qg} + 2\}$ and contiguity set $M_{con} = \{f_k \in F \mid n \leq k \leq n + w_{qg} - 1, f_n \in N_{con}\}$. Finally, considering the resource allocation of J-Sw in the first spatial path, (16) must be in harmony with this decision.

The non-overlapping constraint ensures that each FS in spatial paths of links is assigned to at most one connection demand. This constraint is guaranteed in the above formulation by (17) and the definition of $\zeta_{c,f}^e \in \{0,1\}$.

RMLSSA for J-Sw

$$\text{minimize } u = \sum_{f \in F} o_f, \quad (10)$$

subject to:

$$\sum_{\pi \in \Pi_d} \alpha^\pi = 1, \quad \forall d \in D. \quad (11)$$

$$\sum_{q \in \tilde{Q}_{d,\pi_d}} \beta_q^\pi = \alpha^\pi, \quad \forall d \in D, \forall \pi \in \Pi_d. \quad (12)$$

$$\sum_{\delta \in \Delta} \sum_{f \in F} \chi_{\delta,f}^{\pi,q} = \beta_q^\pi, \quad \forall d \in D, \forall \pi \in \Pi_d, \forall q \in \tilde{Q}_{d,\pi_d}. \quad (13)$$

$$\chi_{\delta,f_n}^{\pi,q} = 0, \quad \forall d \in D, \forall \pi \in \Pi_d, \forall q \in \tilde{Q}_{d,\pi_d}, \quad (14)$$

$$\forall \delta \in \Delta, \forall f_n \in F_{ex}.$$

$$\chi_{\delta_i,f}^{\pi,q} = 0, \quad \forall d \in D, \forall \pi \in \Pi_d, \forall q \in \tilde{Q}_{d,\pi_d}, \quad (15)$$

$$\forall f \in F, \forall \delta_i \in \Delta_{ex}.$$

$$\chi_{\delta_j,f_n}^{\pi,q} - \gamma_{\delta_j,f_n}^{\pi,q} \leq 0, \quad \forall d \in D, \forall \pi \in \Pi_d, \forall q \in \tilde{Q}_{d,\pi_d}, \quad (16)$$

$$\forall \delta_j \in \Delta, \forall f_n \in N_{con}, \forall f_m \in M_{con}.$$

$$\sum_{\pi \in \Pi_d} \sum_{q \in \tilde{Q}_{d,\pi_d}} \gamma_{\delta,f}^{\pi,q} = \zeta_{\delta,f}^e, \quad \forall e \in E, \forall \delta \in \Delta, \forall f \in F. \quad (17)$$

$$\sum_{e \in E} \sum_{\delta \in \Delta} \zeta_{\delta,f}^e - |E| \cdot \theta \cdot o_f \leq 0, \quad \forall f \in F. \quad (18)$$

$$\begin{cases} \alpha^\pi \in \{0,1\}, \forall \pi \in \Pi, \forall q \in \tilde{Q}_{d,\pi_d}. \\ \beta_q^\pi \in \{0,1\}, \forall \pi \in \Pi, \forall q \in \tilde{Q}_{d,\pi_d}. \\ \chi_{\delta,f}^{\pi,q} \in \{0,1\}, \forall \pi \in \Pi, \forall q \in \tilde{Q}_{d,\pi_d}, \forall \delta \in \Delta, \forall f \in F. \\ \gamma_{\delta,f}^{\pi,q} \in \{0,1\}, \forall \pi \in \Pi, \forall q \in \tilde{Q}_{d,\pi_d}, \forall \delta \in \Delta, \forall f \in F. \\ \zeta_{\delta,f}^e \in \{0,1\}, \forall \delta \in \Delta, \forall f \in F, \forall e \in E. \\ o_f \in \{0,1\}, \forall f \in F. \end{cases} \quad (19)$$

The utilized FSs are determined by (18) which forces decision variable o_f to be 1 if frequency slot index f is used in at least one spatial path of the network links. Considering that the total number of FSs with the same index is equal to the number of links multiplied by the number of spatial paths, (18) forces o_f to be 1 if one FS with index f is used. On the other hand, if frequency slot index f is not used at all, the objective function (i.e., (10)) forces o_f to be 0. Finally, (19) shows the range of decision variables of ILP formulation.

It is noteworthy to mention that since the corner FS selection procedure is performed over the entire route, the space and spectrum continuities are ensured without constraints in this formulation. Also, note that decision variables $\chi_{\delta,f}^{\pi,q}$ or $\gamma_{\delta,f}^{\pi,q}$ form the majority of applied decision variables. These decision variables are defined for each demand, each route, each possible SAL, each spatial path, and each FS index. Accordingly, the maximum number of decision variables $\chi_{\delta,f}^{\pi,q}$ or $\gamma_{\delta,f}^{\pi,q}$ equals to $k \times \theta^2 \times \psi$ for each connection demand. Note that the maximum number of SALs is θ .

The ILP formulations lead to optimal solution, but its solving for large networks with huge number of decision variables is time consuming and not efficient. Accordingly, the heuristic algorithms try to find the near-optimal solution by serving the connections one by one in a sorted list. Therefore, the sorting policy of connections affects the near-optimal solution and leads to some optimality gap of solution. In our previous work, we introduced four sorting policies to initiate the heuristic algorithm for Ind-Sw of SS-FONs [18]. But, these sorting policies did not consider the joint switching considerations to sort the connections.

III. HEURISTIC ALGORITHM

Here, we introduce six different sorting policies considering the J-Sw considerations. Then, we propose the J-Sw resource allocation (JSRA) algorithm designed especially for J-Sw with a greedy manner.

A. Sorting Policy

To introduce sorting policies, three metrics are defined for each connection demand based on its required resources properties. We consider three properties for connection demands: (1) the required number of FSs, (2) the number of possible SALs, and (3) the frequency width of SALs.

The number of required FSs is the first property used for sorting. Each connection demand data rate means specified number of FSs in each candidate route based on (5). Accordingly, metric N^d (the summation of n_{d,π_d} of every candidate route of the connection demand) is used as a sorting indicator as in (20).

$$N^d = \sum_{\pi \in \Pi_d} n_{d,\pi_d} \quad (20)$$

Two sorting policies called ascending FS number (AFN) and descending FS number (DFN) are founded on this metric. The connection demand with small N^d is served first in AFN, but served last in DFN. The AFN policy could increase resource fragmentation in contrast to the DFN.

The number of possible SALs is the next property used for sorting connection demands. More number of possible SALs means more flexibility in the ways of resource allocation. Accordingly, metric S^d is defined as summation of all the possible SALs over the candidate routes and can be calculated by (21).

$$S^d = \sum_{\pi \in \Pi_d} |\tilde{Q}_{d,\pi_d}| \quad (21)$$

Two sorting policies called ascending SAL number (ASN) and descending SAL number (DSN) are found on this metric. Similarly, the connection demand with small S^d is served first in ASN, but served last in DSN. Therefore, the connection demand with low flexibility will be served first in ASN according to the resource allocation objective, when the resource allocations are more available and ensuring the resource allocation constraints are more likely. Thus, it seems that ASN might lead to better optimality gap in contrast to DSN.

Now considering Eq. (7) tells that the bigger value of h_q leads to smaller frequency width for the specified connection d . However, the J-Sw paradigm forces the allocation of all the spatial paths to one connection which is translated to $h_q = \theta$ for all possible SALs. Therefore, in J-Sw, all the SALs of connection d require all the spatial paths, but with different frequency widths. Therefore, if one connection could be assigned resources with a SAL that has a frequency width w_{q1} , these resources could be used to allocate d by another SAL with w_{q2} , if and only if $w_{q1} > w_{q2}$. Consequently, considering the network planning objective (minimizing the utilized FSs), it is desirable to choose the SAL with less frequency width to achieve smaller optimality gap. This conclusion means that for each candidate path there is the best possible SAL with the lowest frequency width that is in harmony with minimum utilized FSs (i.e., the resource allocation objective). Therefore, to sort connections in ascending frequency width (AFW) and descending frequency width (DFW), each connection d is mapped to its best possible SAL that has the smallest $w_{q,\pi}$ over route π . Then, metric W^d is calculated as a summation of frequency widths over the candidate routes by (22).

$$W^d = \sum_{\pi \in \Pi_d} w_{q,\pi} \quad (22)$$

In the DFW policy, the connection demand that needs big frequency width is served first when there is more available empty spectrum over the links and accordingly the spectrum continuity constraint could be ensured easily. Then, the connection demands with smaller frequency width could be established over the routes that have empty resources. However, in the AFW policy, the connection demand that needs small frequency width is served first.

Moreover, existing of this best possible SAL over the routes is the idea used in the JSRA algorithm to reduce the complexity of algorithm.

B. Joint Switching Resource Allocation Algorithm

Now, the JSRA algorithm is described that orders connections based on introduced policies. Then, JSRA greedily tries to minimize the used FS index all over the

network in each iteration that allocates one of the connection demands in sequence.

The JSRA (see Algorithm 1) receives inputs as connection demands, candidate routes, and M_{\max}^{π} parameter for each route. Now, for each candidate route of connection demand d , the algorithm determines n_{d,π_d} , Q_{d,π_d} , \tilde{Q}_{d,π_d} and the best possible SAL of each route with the smallest $w_{q,\pi}$ (see Line 2-6). By this way, each connection demand is mapped to its best SAL over the candidate routes. Then, metrics N^d , S^d , and W^d are calculated for each connection demand in Lines 7-9. The sorting of connection demands are carried out based on the desired policy, and the ordered list of connection demands is generated in Line 11.

Now, the resource assignment of connections are started with a connection on top of the list and continued till all the connections are allocated. In every candidate route of connection d , the resource assignment is tested according to the first-fit frequency policy by the best possible SAL. Accordingly, the last FS index f_{\max}^{π} is determined according to the starting point of spectrum assignment and frequency width $w_{q,\pi}$ in Line 14. In the next step, the last FSs indexes of candidate routes are compared and the route with minimum f_{\max}^{π} is chosen. Since for a chosen route, the modulation level M_{\max}^{π} and the best SAL with $w_{q,\pi}$ have been defined before, the route, modulation level, space and spectrum assignment of connection is finalized when parameter f_{\max}^{π} is specified. Note that we have $h_q = \theta$ in J-Sw. Accordingly, in the last step of JSRA, the resource allocation is performed in the chosen route (corresponding to the specified modulation level), and based on the chosen SAL (corresponding to chosen route's $w_{q,\pi}$ and f_{\max}^{π}).

Algorithm 1: Joint Switching Resource Allocation (JSRA)	
1	For each connection d
2	For each candidate route π_d .
3	Calculate n_{d,π_d} based on (5).
4	Determine Q_{d,π_d} and \tilde{Q}_{d,π_d} based on (7) and (9).
5	Find the best SAL with the smallest $w_{q,\pi}$ and keep that SAL.
6	End for
7	Calculate N^d based on (20).
8	Calculate S^d based on (21).
9	Calculate W^d based on (22).
10	End for
11	Sort the connections based on the desired policy.
12	While the sorted list of connections are not empty
13	Select one connection from top of the connection's list
14	Find the allocation parameter f_{\max}^{π} for each candidate route according to the best SAL determined in Line 7.
15	Compare the f_{\max}^{π} of candidate routes and choose the route with minimum f_{\max}^{π} .
16	Assign the space and spectrum for connection.
17	End while

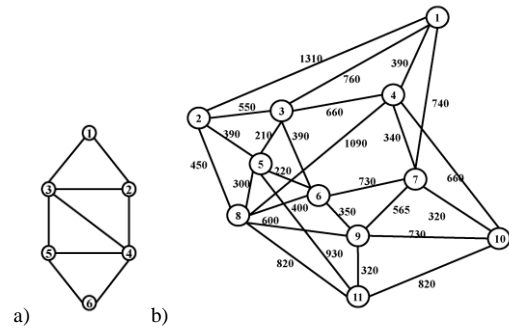

Fig. 3. (a) Small network with six nodes and nine bidirectional links. (b) European Cost239 network. Numbers shows the route length in km.

TABLE III. MODULATION ADAPTIVITY ASSUMPTIONS FOR SMALL NETWORK AND COST239

Small Network	No. of Hops	
	1	4
	2	2
	3	1
COST239	Route length l (km)	
	$l < 500$	4
	$500 < l < 1000$	2
	$1000 < l < 2000$	1
	$l > 2000$	1

The worst case computational complexity of JSRA is equal to $O(|D| \times k \times \theta \times \nu \times |E|)$, where the number of connection demands is $|D|$. It is noteworthy to mention that the corner FS selection is performed for each connection demand, each candidate route, and the best possible SAL. Moreover, the worst case complexity of finding the corner FS to allocate the connection demand is $\theta \times \nu \times |E|$. text edit has been completed, the paper is ready for the template. Duplicate the template file by using the Save As command. In this newly created file, highlight all of the contents and import your prepared text file. You are now ready to style your paper; use the scroll down window on the left of the MS Word Formatting toolbar.

IV. PERFORMANCE EVALUATION

Here, we investigate the performance of JSRA to find the near-optimal solution through simulation experiments with different sorting policies. The results obtained from JSRA are compared to the optimal solution achieved from the proposed ILP formulation. We have used IBM ILOG CPLEX to solve the proposed ILP and Matlab to implement the heuristic algorithms. Also, the simulation is carried out under two network topologies shown in Fig. 3 and repeated for 50 different traffic matrices. For each pair of nodes, the connection bandwidth request is generated as an even integer number of FSs in interval $[nf_{\min}, nf_{\max}]$ with the uniform distribution. For all the simulations, we use $k = 3$ candidate routes, and the multimode fiber with $\theta = 10$ spatial paths. The interval of bandwidth request of connections is twice of spatial paths, i.e., 20.

The small network (shown in Fig. 3.a) is simulated to investigate the JSRA performance to obtain near-optimal solution. The used spectral guardband is 1 FS for the small network. The European COST 239

network (shown in Fig.3 b.) with 11 nodes and 26 bidirectional links is simulated as a realistic network experiment too. The used spectral guardband is 2 FSs for COST 239. The modulation adaptivity based on route length introduced in [22] is used for both networks. The used modulation adaptivity assumptions are summarized in Table III.

The maximum utilized frequency slot index (MUFISI) and the overall spectrum utilization (OSU) [18] are the metrics used to compare the results. The MUFISI is the minimum required FS number that could serve all the connections without blocking. The OSU is an indicator of sparsity/density of spectrum resource utilization over the links as defined in (23).

$$OSU = \frac{total\ utilized\ FS}{MUFISI \times \theta \times number\ of\ links} \quad (23)$$

In Fig. 4, for low and high traffic scenarios of the small network, the optimal MUFISI obtained from ILP and near-optimal MUFISI obtained from different sorting policies are shown. Fig. 4 demonstrates the JSRA capability to find the near optimal solution. Optimality gap of sorting policies are shown in Fig. 5 for low and high traffic scenarios. These two figures demonstrate that the DFW policy achieves the best near-optimal solution in J-Sw. As it is shown in Fig. 5, the optimality gap of DFW is less than ASN, approximately 2 FSs (i.e., over 50% improvement) at low load and 1 FS at high load (i.e., over 20% improvement). It proves that DFW, the policy designed considering the J-Sw resource allocation scheme, is a suitable policy to sort the connections when the J-Sw is the case under study. Moreover, ASN obtains the next better near-optimal solution which considers the flexibility of connections in regard to resource allocation. Accordingly, the AFW and DSN policies showed the worst performance. The performance of DFN and AFN are worse than DFW comparably, even DFN showed good performance for Ind-Sw [18].

Figure 6 shows the OSU for the small network experiment with low and high loads with different sorting policies. It demonstrates that DFW uses the resources in more dense and effective manner that it has more value than the ASN policy. This figure also proves that the sorting policies that used the resources in denser manner leads to less MUFISI.

The obtained results of MUFISI with different policies versus different traffic loads are shown in Fig. 7 for COST239. It shows that the DFW policy achieves lower MUFISI than other policies. The MUFISI improvement for DFW is around 5 percent in the worst case and around 15 % in the best case. It demonstrates that the DFW policy could improve MUFISI value in the realistic network as well.

The OSU versus different traffic loads for the COST239 network is displayed in Fig. 8. It shows that the DFW policy could use available resources in a denser manner than ASN even for the realistic network. It also indicates that the value of OSU has a decreasing trend as the network load increases for both the ASN and DFW policies.

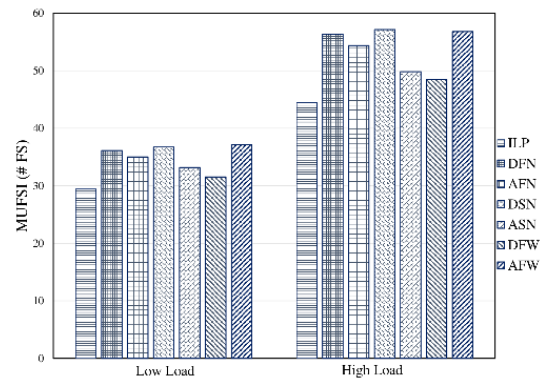

Fig. 4. The MUFISI of J-Sw in the small network at low and high loads

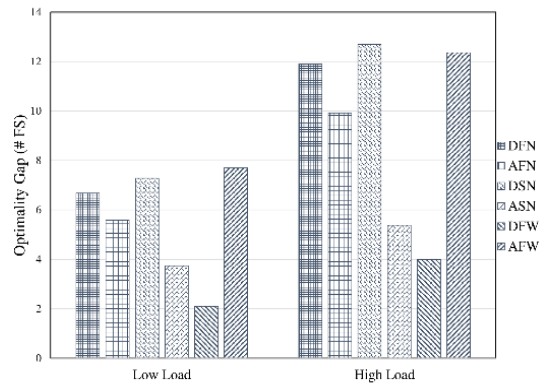

Fig. 5. The optimality gap in the small network at low and high loads

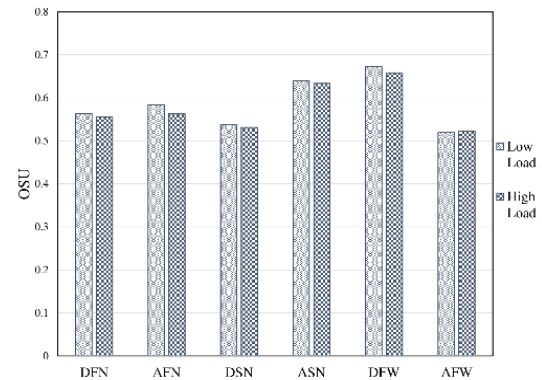

Fig. 6. The OSU in the small network for low and high loads.

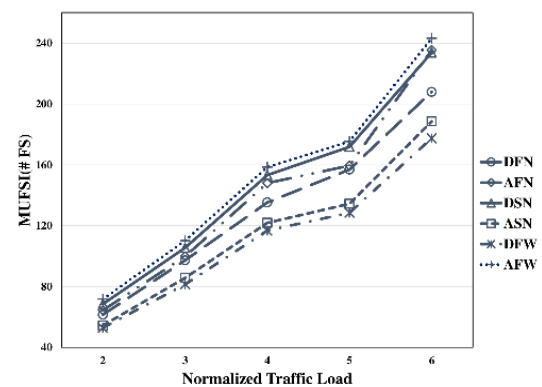

Fig. 7. The MUFISI of J-Sw in COST239 for different loads

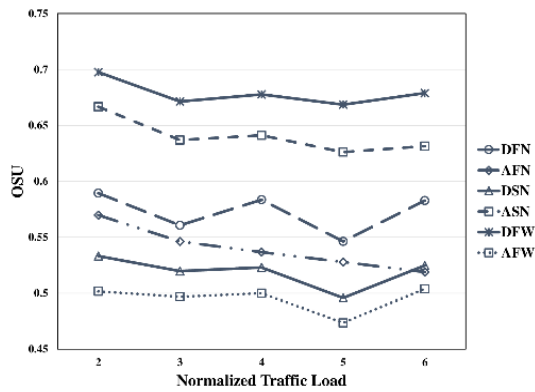

Fig.8. The OSU of J-Sw in COST239 for different loads

V. CONCLUSION

In this paper, we have investigated the networking planning of J-Sw as one of the paradigms for spectrally and spatially flexible optical networks. The integer linear programming formulation of resource allocation for J-Sw has been presented. We have used six sorting policies of connections to initiate resource allocation heuristics. We have also introduced the heuristic joint switching resource allocation algorithm. Then, the performance of JSRA has been evaluated for two network topologies with different traffic loads. The obtained results are compared with each other and [22], and demonstrate that JSRA initiated with the descending frequency width policy could improve the network planning of J-Sw.

REFERENCES

- [1] V. Cisco, "Cisco Visual Networking Index: Forecast and Methodology 2016-2021.(2017)," ed, 2017.
- [2] O. Gerstel, M. Jinno, A. Lord, and S. B. Yoo, "Elastic optical networking: A new dawn for the optical layer?," *IEEE Communications Magazine*, vol. 50, no. 2, 2012.
- [3] M. Jinno, "Elastic Optical Networking: Roles and Benefits in Beyond 100-Gb/s Era," *Journal of Lightwave Technology*, vol. 35, no. 5, pp. 1116-1124, 2017.
- [4] M. Jinno, H. Takara, B. Kozicki, Y. Tsukishima, Y. Sone, and S. Matsuoka, "Spectrum-efficient and scalable elastic optical path network: architecture, benefits, and enabling technologies," *IEEE Communications Magazine*, vol. 47, no. 11, 2009.
- [5] S. Chandrasekhar and X. Liu, "OFDM based superchannel transmission technology," *Journal of lightwave technology*, vol. 30, no. 24, pp. 3816-3823, 2012.
- [6] R.-J. Essiambre, G. Kramer, P. J. Winzer, G. J. Foschini, and B. Goebel, "Capacity limits of optical fiber networks," *Journal of Lightwave Technology*, vol. 28, no. 4, pp. 662-701, 2010.
- [7] T. J. Xia, H. Fevrier, T. Wang, and T. Morioka, "Introduction of spectrally and spatially flexible optical networks," *IEEE Communications Magazine*, vol. 53, no. 2, pp. 24-33, 2015.
- [8] D. Klondis *et al.*, "Spectrally and spatially flexible optical network planning and operations," *IEEE Communications Magazine*, vol. 53, no. 2, pp. 69-78, 2015.
- [9] G. M. Saridis, D. Alexandropoulos, G. Zervas, and D. Simeonidou, "Survey and evaluation of space division multiplexing: From technologies to optical networks," *IEEE Communications Surveys & Tutorials*, vol. 17, no. 4, pp. 2136-2156, 2015.
- [10] P. S. Khodashenas *et al.*, "Comparison of spectral and spatial super-channel allocation schemes for SDM networks," *Journal of Lightwave Technology*, vol. 34, no. 11, pp. 2710-2716, 2016.
- [11] P. J. Winzer, "Spatial multiplexing: The next frontier in network capacity scaling," in *IET Conference Proceedings*, 2013: The Institution of Engineering & Technology.
- [12] L. Nelson *et al.*, "Spatial superchannel routing in a two-span ROADM system for space division multiplexing," *Journal of Lightwave Technology*, vol. 32, no. 4, pp. 783-789, 2014.

- [13] D. M. Marom and M. Blau, "Switching solutions for WDM-SDM optical networks," *IEEE Communications Magazine*, vol. 53, no. 2, pp. 60-68, 2015.
- [14] D. M. Marom *et al.*, "Survey of photonic switching architectures and technologies in support of spatially and spectrally flexible optical networking," *Journal of Optical Communications and Networking*, vol. 9, no. 1, pp. 1-26, 2017.
- [15] D. Siracusa, F. Pederzoli, D. Klondisz, V. Lopezy, and E. Salvadori, "Resource allocation policies in SDM optical networks," in *Optical Network Design and Modeling (ONDM), 2015 International Conference on*, 2015, pp. 168-173: IEEE.
- [16] B. Shariati *et al.*, "Impact of spatial and spectral granularity on the performance of SDM networks based on spatial superchannel switching," *Journal of Lightwave Technology*, vol. 35, no. 13, pp. 2559-2568, 2017.
- [17] B. Shariati *et al.*, "Impact of traffic profile on the performance of spatial superchannel switching in SDM networks," in *ECOC 2016; 42nd European Conference on Optical Communication; Proceedings of*, 2016, pp. 1-3: VDE.
- [18] F. Yousefi and A. G. Rahbar, "Novel fragmentation-aware algorithms for multipath routing and spectrum assignment in elastic optical networks-space division multiplexing (EON-SDM)," *Optical Fiber Technology*, vol. 46, pp. 287-296, 2018.
- [19] A. A. Beyragh, A. G. Rahbar, and M. Nickray, "IDF: Intelligent Defragmentation Method in Elastic Optical Networks based on decision making algorithms," *Optical Fiber Technology*, vol. 52, p. 101978, 2019.
- [20] A. A. Beyragh, A. G. Rahbar, S.-M. H. Ghazvini, and M. Nickray, "IF-RSCA: Intelligent Fragmentation-Aware method for Routing, Spectrum and Core Assignment in Space Division Multiplexing Elastic Optical Networks (SDM-EON)," *Optical Fiber Technology*, vol. 50, pp. 284-301, 2019.
- [21] M. Yaghubi-Namaad, A. G. Rahbar, and B. Alizadeh, "Adaptive Modulation and Flexible Resource Allocation in Space-Division-Multiplexed Elastic Optical Networks," *Journal of Optical Communications and Networking*, vol. 10, no. 3, pp. 240-251, 2018.
- [22] M. Yaghubi-Namaad, A. G. Rahbar, B. Alizadeh, and A. Ghadesi, "Switching adaptable optimization of resource allocation for space division multiplexed elastic optical networks," *Optical Switching and Networking In Press* Available online 16 August 2018. 2018.

AUTHOR BIOGRAPHIES



Mohsen Yaghubi-Namaad received his B.Sc. and M.Sc. degrees from University of Tehran, Tehran, Iran, in 2009 and 2012, respectively, all in Communication Engineering. Then, he achieved his Ph.D. at Sahand University of Technology, Tabriz, Iran in 2018. Currently, he has been with the Iran Telecommunication Research Center (ITRC). His research focuses are

Optical Networks, Space Division Multiplexed Networks, Performance Analysis of Optical Networks, and Wireless Communications.



Akbar Ghaffarpour Rahbar is a Professor in Faculty of Electrical Engineering at Sahand University of Technology, Tabriz, Iran. He received his B.Sc. and M.Sc. degrees in computer Hardware and computer Architecture both from Iran University of Science and Technology, Tehran, Iran, in 1992 and 1995, respectively. He received his Ph.D. degree in Computer Science from

University of Ottawa, Canada in 2006. He is a senior member of the IEEE. His main research interests are Optical Networks, Optical Packet Switching, Scheduling, PON, IPTV, Network Modeling, Analysis and Performance Evaluation, the results of which can be found in over 130 published technical papers (see <http://ee.sut.ac.ir/showcvdetail.aspx?id%413>).



Behrooz Alizadeh received his Ph.D. in Applied Mathematics from Graz University of Technology, Graz, Austria in 2009. He is currently an Associate Professor of operations research and optimization in the Department of Applied Mathematics, Sahand University of Technology, Tabriz, Iran. His main research interests include Facility Location Theory, Network Optimization, Combinatorial Optimization, Discrete Optimization and Inverse Optimization. He also serves as a member of board of directors in the Iranian Operations Research Society since 2013.