

Performance Analysis of Zero Crossing DPLL with Linearized Phase Detector

Qassim Nasir
Department of Electrical and Computer Engineering
University of Sharjah
Sharjah , UAE
nasir@sharjah.ac.ae

Saleh R. Al-Araji
Communication Engineering Department
Khalifa University of Science, Technology and Research
Sharjah , UAE
alarajis@kustar.ac.ae

Received: February 19, 2008- Accepted: July 14, 2009

Abstract—This work introduces a new structure of Zero Crossing Digital Phase Locked Loop with Arc Sine block (ASZCDPLL) to linearize the phase difference detection, and enhance the loop performance. The new loop has faster acquisition, less steady state phase error, and wider locking range as compared to the conventional ZCDPLL. The locking range improvement and faster acquisition have been confirmed through simulation. The loop has been implemented and tested in real time using Texas Instruments TMS320C6416 DSP development kit.

Keywords—non-uniform sampling, digital phase locked loops, zero crossing DPLL

چکیده - ساختار جدیدی از PLL دیجیتال تقاطع صفر با بلوک سینوسی قوسی برای خطی سازی آشکار سازی اختلاف فاز و به سازی عملکرد حلقه (لوپ) پیشنهاد می گردد. این حلقه جدید از توانمندی اکتساب سریع تر خطای کمتر فاز حالت مانا و بازه قفل کردن پهن تری در مقایسه با ZCDPLL، مرسوم برخوردار است. شبیه سازی کامپیوتری موید بهتر شدن بازه قفل کردن و اکتساب سریع تر می باشد.

این حلقه به طور بیدرنگ و با به کارگیری ابزار توسعه DSP (پردازش سیگنال های دیجیتال) کمپانی Texas Instruments پیاده سازی گردیده است.

I. INTRODUCTION

Phase Lock Loops (PLLs) are widely used in variety of areas of communication applications such as carrier recovery, synchronization, and demodulation [1]. A PLL is a closed loop system in which the phase output tracks the phase of the input signal. It consists of a phase detector, filter, and voltage controlled oscillator. Digital Phase locked Loops (DPLLs) were introduced to minimize some of the problems associated with the analogue counter part such as sensitivity to DC drift and the need for periodic adjustments [2], [1]. Conventional Zero Crossing DPLL (ZCDPLL) is the most widely used due to its simplicity in modelling and implementation [3], [4]. In this paper a new structure of ZCDPLL is introduced which includes Arc-Sine block and a peak detector in addition to the main ZCDPLL main components. The purpose of including the Arc-Sine in the loop is to linearize the phase difference detection. The peak detector guarantees the input amplitude to the Arc-Sine block to remain between -1 and +1. The newly proposed Arc-Sine ZCDPLL (AS-ZCDPLL) is analyzed and simulated and its performance is compared to the conventional ZCDPLL (ZCDPLL). It has been shown that the proposed loop offers improved performance in the lock range and acquisition with reduced steady state phase error. The proposed AS-ZCDPLL can be characterized by a linear difference equation in module ($\frac{\pi}{2}$) sense. The

AS-ZCDPLL loop has been implemented and tested using Texas Instruments TMS320C6416 DSP development kit. In section 2, system description of AS-ZCDPLL is given, then the first order loop stability requirement and the range of operation of the first order loop is presented in section 3. Section 4 discusses the performance of the second order ASZCDPLL. In section 5 the simulation results are presented while section 6 discusses the real time implementation of the proposed loop. Finally conclusions are given in section 7.

II. SYSTEM DESCRIPTION

The AS-ZCDPLL is composed of a sampler as a phase detector, inverse sine block, a digital loop filter and a Digital Controlled Oscillator (DCO). The input signal to the loop is taken as $x(t) = s(t)+n(t)$, where $s(t) = A\sin(\omega_0 t + \theta(t))$, $n(t)$ is Additive white Gaussian Noise (AWGN); $\theta(t) = \theta_0 + \Omega_0 t$ from which the signal dynamics are modelled; θ_0 is the initial phase which we will assume to be zero; Ω_0 is the frequency offset from the nominal value ω_0 . The input signal is sampled at time instances t_k determined by the Digital Controlled Oscillator (DCO). The DCO period control algorithm as given by [2] is

$$T_k = T_0 - c_{k-1} = t_k - t_{k-1} \tag{1}$$

where $T_0 = (2\pi / \omega_0)$ is the nominal period, c_{k-1} is the output of the loop digital filter $D(z)$. The sample value of the incoming signal $x(t)$ at t_k is

$$x(t_k) = s(t_k) + n(t_k) \tag{2}$$

or

$$x_k = s_k + n_k \tag{3}$$

where $s_k = A\sin[\omega_0 t_k + \theta(t_k)]$. The sequence x_k is passed through the Arc-Sine block with output $y_k = \sin^{-1}(x_k)$. The output is passed through a digital filter $D(z)$ whose output c_k is used to control the period of the DCO. The time instances t_k can be rewritten as

$$t_k = \sum_{i=1}^k T_i = kT_0 - \sum_{i=0}^{k-1} c_i, k = 1,2,3... \tag{4}$$

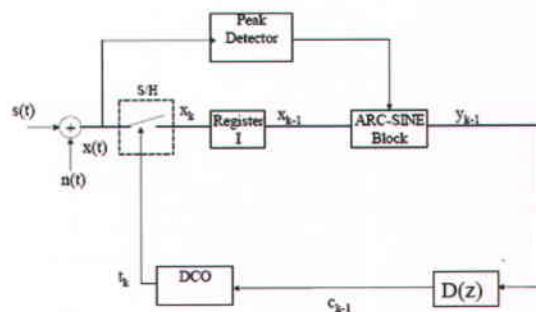

Figure 1: Block diagram of the AS-ZCDPLL

Thus

$$x_k = A \sin[\omega_0(kT_0 - \sum_{i=0}^{k-1} c_i)] + n_k \tag{5}$$

For noise free analysis $n_k = 0$, then

$$x_k = A \sin[\omega_0(kT_0 - \sum_{i=0}^{k-1} c_i) + \theta_k] \tag{6}$$

The phase error is defined to be [2]

$$\phi_k = \theta_k - \omega_0 \sum_{i=0}^{k-1} c_i \tag{7}$$

Also

$$\phi_{k-1} = \theta_{k-1} - \omega_0 \sum_{i=0}^{k-2} c_i \tag{8}$$

Taking the difference of (7) and (8) results in

$$\phi_k - \phi_{k-1} = \theta_k - \theta_{k-1} - \omega_0 c_{k-1} \tag{9}$$



The Arc-Sine (\sin^{-1}) block has been added to linearize the equation and avoid the nonlinear behaviour of the systems. The output of the Arc-Sine block can be expressed as $y_k = \sin^{-1}(x_k) = \phi_k$, $-1 \leq x_k \leq 1$, and $-\frac{\pi}{2} \leq y_k \leq \frac{\pi}{2}$. The z transform of the output of the digital filter is

$$C(z) = D(z)Y(z) \tag{10}$$

Where $Y(z)$ is the z transform of $y(t)$. The order of the loop is determined by the type of the digital filter. For first order, the digital filter is simply a gain block $D(z) = G_1$, where G_1 is the block gain. However, for second order loop, $D(z) = G_1 + \frac{G_2}{1-z^{-1}}$ as will be shown in what follows.

III. FIRST ORDER AS-ZCDPLL

In this paper, the behaviour of the first order AS-ZCDPLL for an input with frequency offset in the absence of noise is analyzed and simulated. If the input to AS-ZCDPLL is a frequency step with $\Omega_0 = (\omega - \omega_0)$ is applied, then $\theta_k = (\omega - \omega_0)t_k$. Using (4), then

$$\phi_k - \phi_{k-1} = (\omega - \omega_0)T_0 - (\omega - \omega_0)c_{k-1} \tag{11}$$

(9) can also be rewritten as

$$\phi_k = \phi_{k-1} - k_1\phi_{k-1} + \Lambda_0 \tag{12}$$

where

$$\Lambda_0 = (\omega - \omega_0)T_0 = 2\pi \frac{(\omega - \omega_0)}{\omega_0}, K_1 = \omega G_1$$

The steady state phase error ϕ_{ss} must satisfy

$$\phi_{ss} = (1 - K_1)\phi_{ss} + \Lambda_0 \tag{13}$$

Since $\phi_k = \phi_{k-1} = \phi_{ss}$ in the steady state. Accordingly

$$\phi_{ss} \text{ will be } \phi_{ss} = \frac{\Lambda_0}{k_1}$$

In order for the loop to achieve locking, first ϕ_{ss} must lie in the interval $(-\frac{\pi}{2}, \frac{\pi}{2})$ and this comes from the properties of the inserted arc sine block, or

$$\left| \frac{\Lambda_0}{K_1} \right| \leq \frac{\pi}{2} \tag{14}$$

This will lead to that $K_1 > 4 \frac{\omega - \omega_0}{\omega_0}$.

Let $\Psi_k = \phi_k - \phi_{ss}$, the equation (12) can be rewritten as

$$\Psi_k = (1 - K_1) \Psi_{k-1} \tag{15}$$

Taking the z-transform of both sides of equation (15) and solving for $\Psi(z)$, then

$$\Psi(z) = \frac{\psi(0)z}{z - (1 - K_1)} \tag{16}$$

the loop will be locked if the roots of the denominator lies inside the unit circle and this will lead to the inequality

$$|1 - K_1| < 1, K_1 < 2 \tag{17}$$

The steady state phase error ϕ_{ss} of the first order conventional ZCDPLL (ZCDPLL) for an input with frequency offset is give by [7]:

$$\phi_{ss} = \sin^{-1}\left(\frac{\Lambda_0}{K_1}\right), \text{ for } \frac{\Lambda_0}{K_1} < 1 \tag{18}$$

Since $\left| \frac{\Lambda_0}{K_1} \right| < \left| \sin^{-1}\left(\frac{\Lambda_0}{K_1}\right) \right|$ for $\left| \frac{\Lambda_0}{K_1} \right| < 1$, it is clear that steady state phase error of AS-ZCDPLL is always less than that of ZCDPLL for the same values of Λ_0 , and K_1 . Another advantage of AS-ZCDPLL is that the gain $K_1 = \omega G_1$ is independent of the signal power, while ZCDPLL gain $K_1 = AwG_1$ is power dependent. For optimum value of filter gain, the loop could go into instability if the signal power increases. The ZCDPLL requires an Automatic Gain Control (AGC) circuit to overcome this problem. It is also interesting to show the performance of AS-ZCDPLL when the frequency is varied with the same value of G_1 (filter gain). Define

$K = G_1\omega_0 = K_1 \frac{\omega_0}{\omega}$. Since $\Lambda_0 = 2\pi(\frac{\omega}{\omega_0} - 1)$, then the lock range can be expressed as

$$\left| 1 - \frac{\omega}{\omega_0} \right| < K_1 < 2 \tag{19}$$

Figure (2) shows that the lock range of the first order ASZCDPLL for different values of K and $\frac{\omega_0}{\omega}$ (area enclosed between the lines (3),(4), and (5)), together with ZCDPLL obtained from [7] (Area enclosed between curves (1) and 2)). It is clearly shown that AS-ZCDPLL has wider lock range.

IV. SECOND ORDER AS-ZCDPLL

As mentioned earlier, for second order ZCDPLL the digital filter $D(z) = G_1 + \frac{G_2}{1-z^{-1}}$, then (10) becomes

$$C(z) = (G_1 + \frac{G_2}{1-z^{-1}})Y(z) \tag{20}$$

$$C(z)(1-z^{-1}) = (G_1(1-z^{-1}) + G_2)Y(z)$$



To express in time domain

$$c_k = c_{k-1} + (G_1 + G_2)y_k - G_1y_{k-1} \quad (21)$$

Since $y_k = \phi_k$, and by replacing k by $(k-1)$ into equation (21), then

$$c_{k-1} - c_{k-2} = (G_1 + G_2)\phi_{k-1} - G_1\phi_{k-2} \quad (22)$$

Replacing k by $k-1$ in equation (11) results in

$$\phi_{k-1} - \phi_{k-2} = (\omega - \omega_0)T_0 - (\omega - \omega_0)c_{k-2} \quad (23)$$

Taking the difference of (23) and (11) leads to

$$\phi_k - 2\phi_{k-1} + \phi_{k-2} = \omega(c_{k-2} - c_{k-1}) \quad (24)$$

Replacing $c_{k-2} - c_{k-1}$ of equation (22) into equation (24) results in

$$\phi_k - 2\phi_{k-1} + \phi_{k-2} = -\omega((G_1 + G_2)\phi_{k-1} - G_1\phi_{k-2}) \quad (25)$$

Let $r = 1 + \frac{G_2}{G_1}$, and $K_1 = \omega G_1$ then

$$\phi_k = (2 - K_1r)\phi_{k-1} + (K_1 - 1)\phi_{k-2} \quad (26)$$

Define the system state vector $x_k^1 = y_{k-2}, x_k^2 = y_{k-1}, X = (x^1, x^2)^T$, then

$$\begin{pmatrix} x_{k+1}^1 \\ x_{k+1}^2 \end{pmatrix} = \begin{pmatrix} x_k^2 \\ (K_1 - 1)x_k^1 + (2 - K_1r)x_k^2 \end{pmatrix} = \begin{pmatrix} g_1(x) \\ g_2(x) \end{pmatrix} = G(x_k) \quad (27)$$

The Jacobian $G'(X) = \partial_{g_i} / \partial_{x^j}$ is given by

$$G'(X) = \begin{pmatrix} 0 & 1 \\ K_1 - 1 & 2 - K_1r \end{pmatrix} \quad (28)$$

In order to have Eigen values of $G'(x)$ less than 1, or $|\lambda_i| < 1, i=1,2$, where $|\lambda_i|$ satisfies the characteristic equation $F(\lambda) = |\lambda I - G'(X^*)| = 0$ [5]

$$F(\lambda) = \lambda^2 - (2 - K_1r)\lambda - (K_1 - 1) = 0 \quad (29)$$

Using Jury stability test [5], the roots of the polynomial $F(\lambda)$ defined in (29) will have roots within a unit circle, or the eigenvalues are less than 1, if $(-1)^2 F(-1)$ greater than 0. This will lead that K_1 should be less than $\frac{4}{r+1}$ to ensure stable loop behaviour.

Also from the Jury stability test applied on $F(\lambda)$, $|K_1 - 1|$ should be less than 1 or $K_1 < 2$, so r should be greater than 1, which of course is the same as [8] but without linearizing the equations. Figure (3) shows the second order loop stability region. For optimum values in terms of acquisition time, $K_1 = 1$, and $r = 2$ [8].

Assume $K_{10} = \omega_0 G_1$, which is independent of the frequency as the nominal frequency ω_0 is assumed to be constant, then $K_1 = K_{10} \frac{\omega}{\omega_0}$, therefore the second order frequency acquisition range becomes:

$$\frac{r+1}{4} K_{10} < \frac{\omega_0}{\omega} < \infty \quad (30)$$

The borders on K_{10} for stability as a function of $\frac{\omega_0}{\omega}$ in Figure (4) under the condition $r = 2$. For second order loop, there is no limit to the amount of ω can decrease for a given value of K_{10} , but there is a limit to the increase in the frequency above the nominal value.

V. SIMULATION RESULTS

The operation behaviour of the AS-ZCDPLL has been verified by simulation. Consider a modulation free input signal $y(t) = \sin(\omega_1 t)$, where ω_1 is the input frequency, the center frequency of the DCO is assumed to be $\omega_0 = 1$ rad/sec. After discarding the first 100 points, the next 100000 points are collected and recorded to produce bifurcation. The bifurcation plot of the first order AS-ZCDPLL is provided in figure (5) for different values of the filter gain.

To verify that AS-ZCDPLL has better acquisition time compared to ZCDPLL, the loop is subjected to a frequency step with random initial phase. The acquisition time is estimated and recorded when the loop starts converging to the desired frequency. This operation is repeated 100 times with random initial phase and the acquisition time is recorded for that frequency step. It can be seen from figure (6) that ASZCDPLL has faster acquisition time compared to ZCDPLL for all frequency offsets. K_1 has been kept constant through the simulation and set to be equal to 1 which is optimum value for the loop. The AS-ZCDPLL has been tested with Frequency Shift Keying (FSK) input signal with random transmitted data and it can be seen from figure (7) that the AS-ZCDPLL operation is better than its equivalent ZCDPLL.

The second order AS-ZCDPLL bifurcation plot is shown in figure (8). The loop parameter r is assumed to be 2, while K_1 is varied. The figure shows that the second order AS-ZCDPLL has wider locking range compared to the conventional second order ZCDPLL. Second order AS-ZCDPLL has faster acquisition time as shown in Figure (9).

VI. SYSTEM IMPLEMENTATION

To test the loop under real time conditions, the first order loop has been selected for this purpose. The loop has been implemented in the software code targeted at a Texas Instruments TMS320C6416 DSP. The key issue in the realization of ASZCDPLL is the implementation of variable sample rate signal processing and inverse sign block. In the realization based of DSP, variable sampling rate can be



[Downloaded from journal.ijict.ac.ir on 2024-04-20]

efficiently implemented using the DSP chip timer. At the beginning of the software program, the DSP timer (e.g Timer1) is set to be equal to maximum value of the sampling period. While the timer counts towards zero, an input (error) sample is read from the Analogue to Digital converter (ADC). On the basis of the error sample, the controller output and the actual value of the sampling period T are computed. Then the computed value of

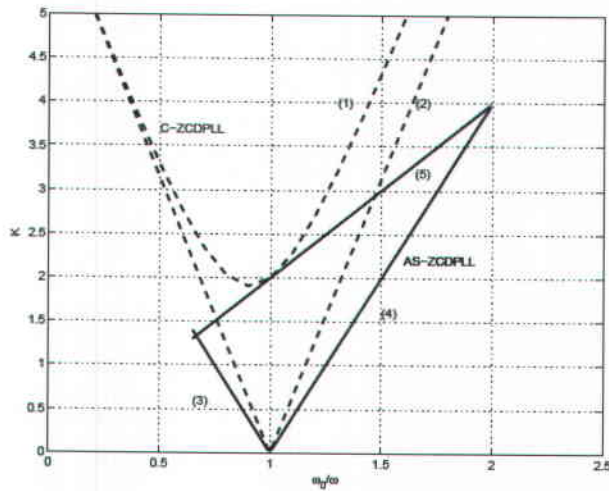

Figure 2: Lock Range of first order AS-ZCDPLL compared to ZCDPLL

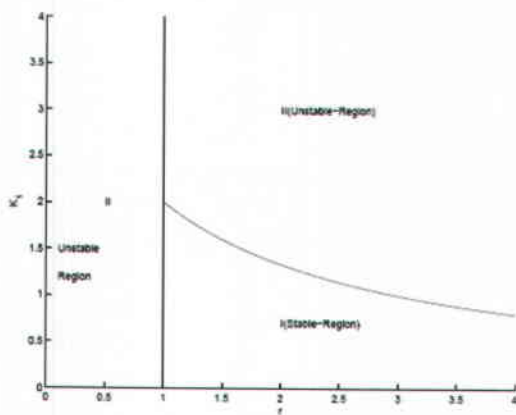

Figure 3: Loop behaviour as a function of K1 and r for second-order ZCDPLL

the sampling period is used to set the timer period. The DSP processor will enter an idle state till the timer expired, then the processed will be interrupted and the Interrupt Service Routine (ISR) will be called and the program loop repeats. Real-Time Data Exchange (RTDX) is used to provide real time, continuous visibility into the way AS-ZCDPLL software application operates in TMS320C6416. RTDX allows transfer the random bits generated in the DSP to a host PC for testing. On the host platform, an RTDX host library operates in conjunction with Code Composer Studio. In RTDX an output channel should be configured within AS-ZCDPLL software. Data is written to the output channel. This data is immediately recorded into a C6416 DSP buffer defined in the RTDX C6416 library. System block

diagram of the implemented system is shown in figure (10). The data from this buffer is then sent to the host PC through the JTAG interface. The RTDX host library receives this data from the JTAG interface and records it into either a memory buffer for testing purposes. To approximate $\sin^{-1}(\cdot)$, the following is proposed in this

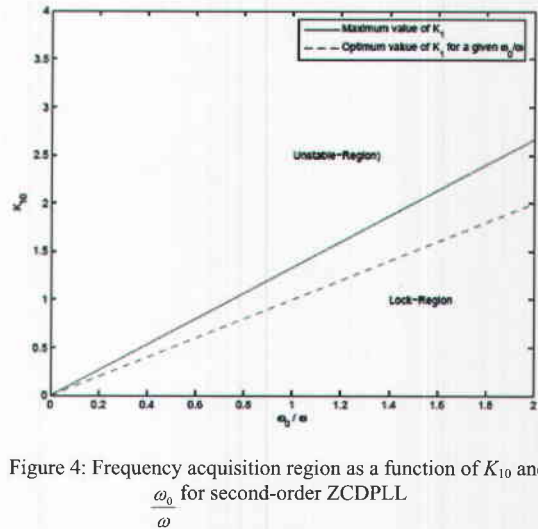

Figure 4: Frequency acquisition region as a function of K_{10} and $\frac{\omega_0}{\omega}$ for second-order ZCDPLL

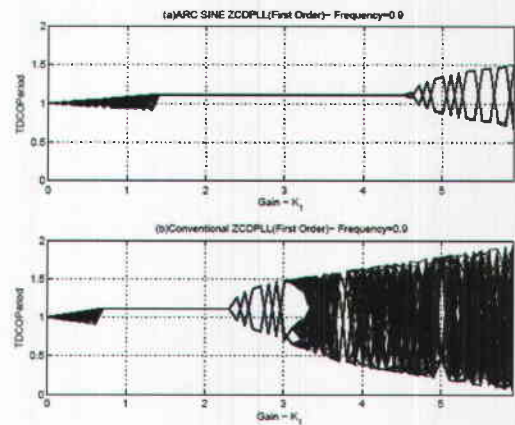

Figure 5: Bifurcation of First order AS-ZCDPLL compared to ZCDPLL

work. Recall the following integral formula [9]:

$$\sin^{-1}(x) = \int_0^x \frac{1}{\sqrt{1-t^2}} dt \tag{31}$$

Also recall

$$(1+x)^\alpha = 1 + \binom{\alpha}{1}x + \binom{\alpha}{2}x^2 + \binom{\alpha}{3}x^3 + \dots \tag{32}$$

The above equation holds for any real number α , where the binomial number is [9]:

$$\binom{\alpha}{k} = \frac{\alpha(\alpha-1)\dots(\alpha-k+1)}{k!} \tag{33}$$

Now let $\alpha = -\frac{1}{2}$, then



$$(1-t^2)^{-\frac{1}{2}} = 1 + \left(\frac{1}{2}\right)(-t^2) + \left(\frac{1}{2}\right)(-t^2)^2 + \dots \quad (34)$$

So equation (20) will be as

$$\sin^{-1}(x) = \int 1 dt + \int \left(\frac{1}{2}\right)(-t^2) dt + \int \left(\frac{1}{2}\right)(-t^2)^2 dt + \dots \quad (35)$$

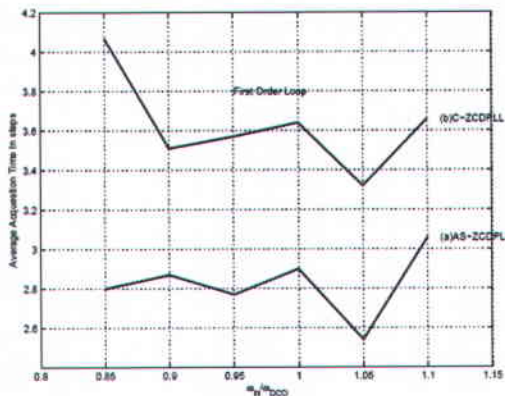

Figure 6: Acquisition Time of first order AS-ZCDPLL compared to ZCDPLL

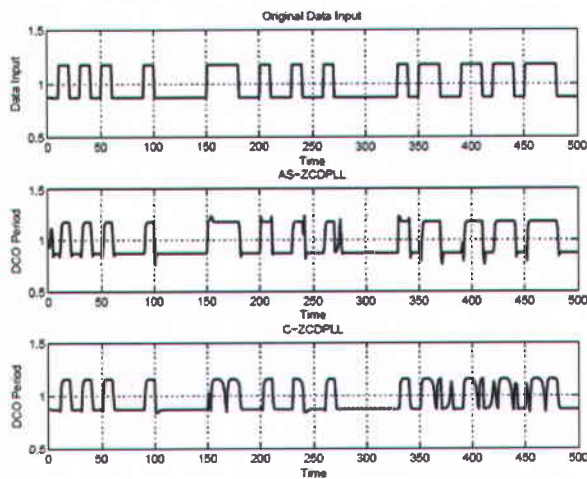

Figure 7: FSK performance of first order AS-ZCDPLL compared to ZCDPLL

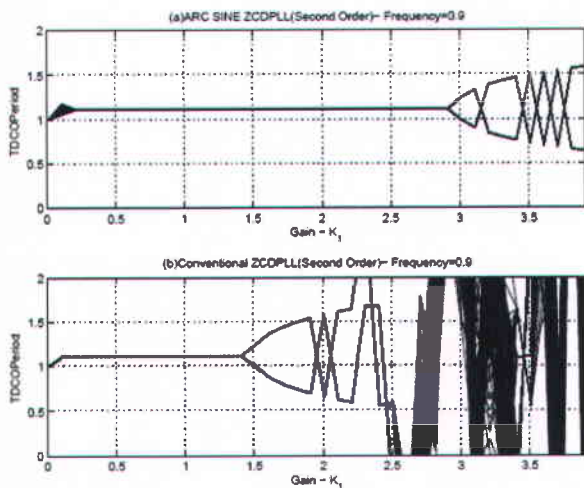

Figure 8: Bifurcation of second order AS-ZCDPLL compared to ZCDPLL

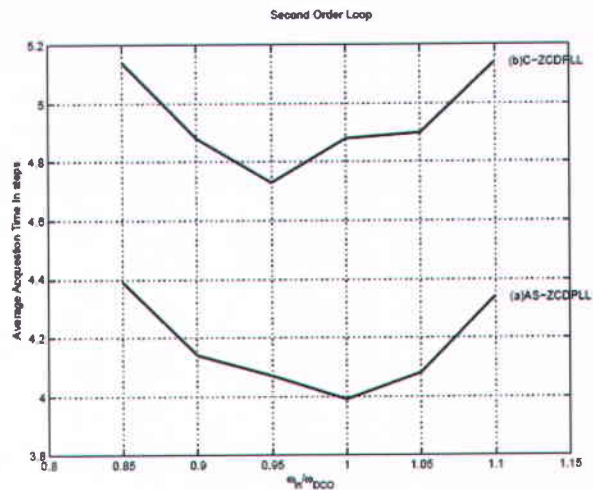

Figure 9: Acquisition Time of second order AS-ZCDPLL compared to ZCDPLL

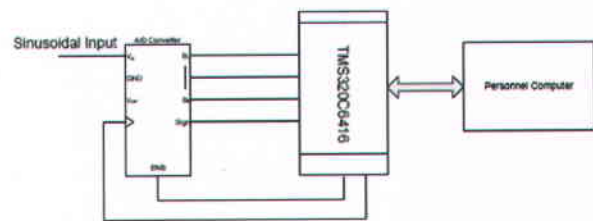

Figure 10: TMS320C6416 Based AS-ZCDPLL

Using equation (22), equation (24) will be after taking only three terms:

$$\sin^{-1}(x) \approx x + \frac{1}{6}x^3 + \frac{3}{40}x^5 \quad (36)$$

In the DSP implementation only two terms has been taken. Figure (11) shows MATLAB plot of actual \sin^{-1} and two terms approximation of the arc sine using the above approach.

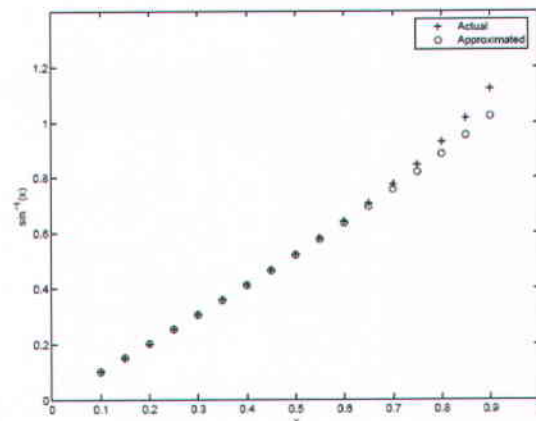

Figure 11: \sin^{-1} Approximation compared with Actual one

VII. CONCLUSIONS

It has been shown that the proposed AS-ZCDPLL loops have many attractive features compared to the conventional ZCDPLL. These include faster



acquisition, wider lock range, insensitivity to input signal power variation and reduced steady state phase error. The proposed loops have shown a clear performance improvement over the conventional one as shown in figures (4, 5, 7, and 8). Also the AS-ZCDPLL can have smaller values of gain compared to ZCDPLL and thus it has more immunity to noise. The first order AS-ZCDPLL has been implemented and tested in real time using Texas Instruments TMS320C6416 DSP development kit.

REFERENCES

- [1] F. M. Gardner, Phase lock Techniques, Wiley, John and Sons, Incorporated, 3rd Edition, 2005.
- [2] Q. Nasir , S. R. Al-Araji , "Optimum Performance Zero Crossing Digital Locked Loop using Multi-Sampling Technique, IEEE International Conference On Electronics, Circuits and Systems ,pp. 719-722, 2003.
- [3] Q. Nasir, "Digital Phase Locked Loop with Broad Lock Range Using Chaos Control Technique," *AutoSoft - Intelligent Automation and Soft Computing*, vol. 12, no. 2,pp. 183-186, 2006.
- [4] Q. Nasir, "Extended Lock Range Zero Crossing Digital Phase Locked Loop with Time Delay" *IEURASIP JWCN* , pp. 413-418, 2005.
- [5] Q. Nasir," Chaos Controlled ZCDPLL for Carrier Recovery in Noisy Channels", *Wireless Personal Communications*, Volume 43 , Issue 4 , December 2007, 1577 1582.
- [6] Texas Instruments, "<http://focus.ti.co/docs/toolssw/folders/print/tmsdsk6416.html> "TMS320C6416 DSP Starter Kit (DSK)
- [7] H.C. Osborne, "Stability Analysis if an Nth Power Phase-Locked Loop -Part I: First Order DPLL" *IEEE Transactions on Communications*, vol. 28, no. 8,pp. 1343-1354, Aug. 1980.
- [8] H.C. Osborne , " Stability Analysis if an Nth Power Phase-Locked Loop -Part II: Second- and Third Order DPLL's " *IEEE Transactions on Communications* , vol. 28, no. 8,pp. 1355-1364, Aug. 1980.
- [9] R. G. Bartle, D. R. Sherbert, "Introduction to real analysis",3rd edition, John Wiley , 2000.



Qassim Nasir received the B.Sc., M.Sc., and Ph.D. degrees from the University of Baghdad, Iraq, in 1977, 1984, and 1994 respectively. Prior to joining the University of Sharjah, UAE in 2001 and for six years, Dr. Nasir was working with Nortel Networks, Canada, as a senior system designer in the network management group for OC-192 SONET. He later moved to work with the DSL group, at the same company, as a senior firmware system designer, for GLite Nortel Modems. He was adjunct part time assistant professor at Ottawa University, for the period 1999 to 2001, teaching telecommunication software engineering. Dr. Nasir was visiting professor at Helsinki University of Technology, Finland, during the summers of 2002 to 2009. He also worked as an assistant professor at Amman University during the academic year 1994/1995. Dr. Nasir's research interests are digital communications, chaos in communications, and power aware MANETs.



Prof. Saleh Al-Araji is Head of the Communication Engineering Department at Khalifa University of Science, Technology and Research, Sharjah, UAE, a position held since September 2002. Prior to that and for six years he was working at the Transmission Network Systems, Scientific-Atlanta, Atlanta, Georgia, USA as Senior Staff Electrical Engineer. During the academic year 1995/1996, Prof. Al-Araji was visiting professor at the Ohio State University, Columbus, Ohio, USA. He was also visiting professor at King's University, University of London, UK, during the summers of 1988 and 1989. He was professor and Department Head at the University of Baghdad, Iraq, and the University of Yarmouk, Jordan. Prof. Al-Araji was awarded the 1976 British IERE Clerk Maxwell Premium and the Scientific-Atlanta award for outstanding achievement in the year 2000. He was an Iraqi National member of URSI Commissions C and D, and the ITU (CCIR Group 8). He has published around 50 papers in international Journals and Conferences and holds 5 issued US Patents and one International Patent. Prof. Al-Araji received the B.Sc., M.Sc., and Ph.D. degrees from the University of Wales Swansea, UK, in 1968, 1969, and 1972 respectively. He is a senior member of the IEEE.

